

MOUNTING INSTRUCTION INGROUND SERIES

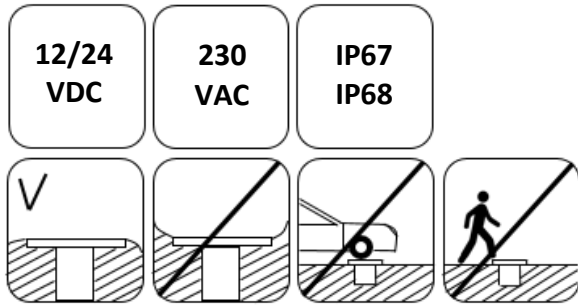

1

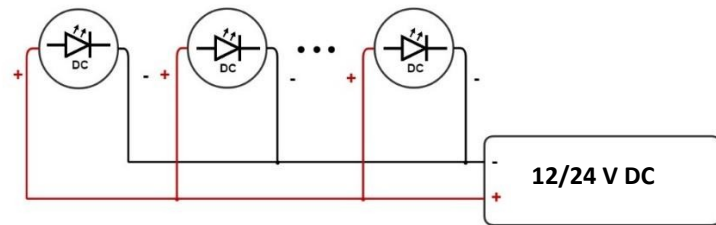

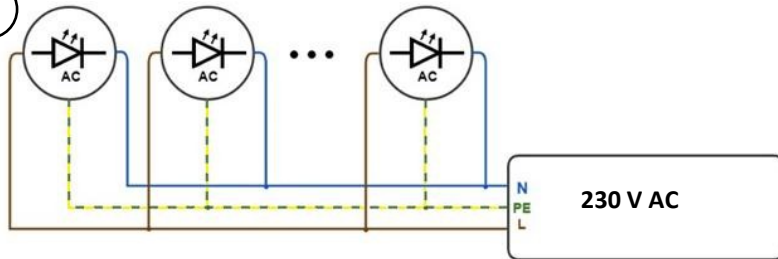

2

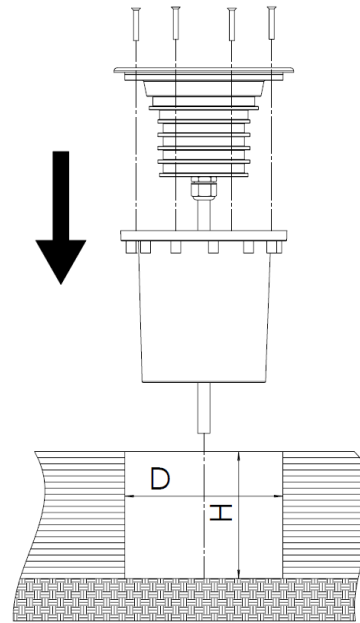

3



4

			D [mm]	H [mm]
Inground Standard	GROUND-STANDARD-ABS-1		81,3-82	108



Read completely before installation and keep it for reference

STORAGE AND DISPOSAL

- The product must be stored in a clean and dry environment. Do not strain the product mechanically during storage.
- ▲ Do not dispose the product with the regular household waste! Products marked with this sign must be disposed according to the directive(WEEE, 2012/19) on electrical and electronic devices at local collection points for such devices!

INSTALLATION

- Prepare the mounting hole according to ④ if not done yet. When installing lighting unit outdoors provide a gravel bed, 20 cm thick, beneath the installation pot. This serves as drainage of water.
- Install the luminaire as shown in the ③
- Do not exceed bend radius-4x wire diameter.
- Luminaire replacement must be easy to do.
- Inspect the product for loose parts inside the housing. When there are loose parts inside the housing and these are not explicitly described the product may not be installed or operated.
- Use the supplied fastening material only when it is suited for the installation background. In other case use only fastening material suiting the installation background.
- This product may be operated only when firmly mounted on a stable, even and tilt-fixed, and non flammable surfaces.
- Intended for outdoor use!

ELECTRICAL CONNECTION

- ▲ Installation, mounting or works on the electrical connection may only be carried out by an approved electrician.
- ▲ Always switch off the mains or respectively the connection lead before doing any works!
- ▲ Use only parts, which are supplied with the product or are described as accessories.
- Establish the connection as shown in the ① (12/24VDC), ②:230 VAC
- The product must be able to be separated by an all pole separation from the current supply (12/24VDC).
- Connect positive and negative supply pole with suitable luminaire poles (12/24VDC)
- Connect the black or brown, blue and yellow-green lamp wires with the corresponding wires in the installation (230 VAC).
- All connections must be properly protected and sealed against penetration of water and dirt!
- Cutting cable and their improper protection may result in rejection of any complaint.

▲ **Check if the product functions properly and is securely fixed!**

▲ **This product may be only installed according to safety class III (12/24VDC)  or class I (230 VAC) **

SAFETY WARNINGS

- ▲ Installation, mounting or works on the electrical connection may only be carried out by an approved electrician.
- ▲ The connection cord cannot be replaced when damaged. Do not operate the product with a damaged connection cord. In this case the complete product must be disposed.
- ▲ Do not look directly into the light source.
- ▲ The cable of the luminaire may not be placed underground without protective tube .
- ▲ The product may not be modified or converted.
- ▲ Do not cover the product - provide free air circulation.
- ▲ The luminaire may only be operated with a complete and intact protection glass.
- ▲ In case of a malfunction you may NOT touch the product or operate it further. Disconnect the product from the power supply by an external switch or by the fuse. A malfunction exist when: visible damages appear, flickering, smoke or smell appear, overheating ect.
- ▲ Do not fasten or hang anything on the product, especially decorative elements
- ▲ Do not exposed to strong mechanical loads or strong contamination

MAINTENANCE AND CARE

- The light source of this luminaire is not replaceable. In case that the light source must be replaced (e.g. at the end of its lifetime) the whole luminaire needs to be replaced.
- Before cleaning, disconnect the luminaire from the power supply and let it cool down
- Regularly clean luminaire from dirt, deposits and leaves.
- In luminaries with protection class above IP65, high pressure cleaner can be used.

ADVICES FOR CLEANING AND MAINTAINING HIGH-GRADE-STEEL

Stainless high-grade is corrosion proof. Passive layer protects the high-grade steel and it rebuilt itself when the surface get damage. To achieve good appearance surface must be cleaning.

■ **Examples for different type of high-grade steel**

High-grade steel 304- good resistance against corrosion in absence of chlorine and salt concentrations. Not seawater and saline atmosphere resistant.
High-grade steel 316- good resistance against corrosion in areas with low chlorine and salt concentrations. Not seawater resistant.

■ **Basic cleaning**

The basic cleaning should be done before customer receives the product

■ **Pollutions on construction sites**

The surface should be protected by coverings
Lime and mortar splashes are removed using diluted phosphorous acid.
After application the surface should be cleaned with clean, demineralized water.
Iron particles must be removed at once. For example with a sponge. Otherwise rusty particles could penetrate the passive layers and lead to selective corrosion.

■ **Maintenance cleaning**

Outdoor applications- The cleaning effect of rain is usually sufficient. In areas with higher concentrations of chlorines and Sulphur dioxides surface cleaning is important to avoid deposits.
Indoor applications- Main stains is a fingerprints

■ **Cleaning agents and equipment**

Light dirt and soiling could be removed by damp towel. Dish washing liquid or glass cleaner also can be used.

Persistent dirt can be remove by cleansing milk without scouring additives.

Do not use scouring powder or steel wool!

■ **Oily and greasy soiling**

This kind of soiling can be removed with cleaners containing alcohol. It could be isopropyl alcohol, acetone or spirit. Dirt and streaks must be removed completely. A sponge and soft nylon brush may be used.

Metal brushes can not be used! After that surface must be cleaning by demineralized water.

Note the manufactures instruction when you use a special high-grade steel cleaning

■ **Do not used in any case**

Agents containing chlorine or hydrochloric acid
Cleaners for silverware
Bleaching agents
Cleaners and agents with scouring additives

■ **Cleaning intervals**

3-4 times a years - in areas with a higher than usual corrosive pollution, or with pollution caused by salt, exhausts or air pollution

1-2 times a year – in areas where such pollutions are reduced or absent

Cleaning should make before a lot of dirt or stains become evident

Installation steps (read completely before installation)

1. Prepare the recessed (if not done yet). When installing the lighting unit outdoors provide a gravel bed, 20 cm thick, beneath the installation pot. This serves as drainage of water.
2. Install the luminaire as shown in the [Figure 1](#).

Electrical Connection

1. Installation, mounting or works on the electrical connection may only be carried out by a qualified electrician.
2. Always switch off the mains or respectively the connection lead before doing any works!
3. Use only parts, which are supplied with the product or are described as accessories!
4. All connections must be properly protected and sealed against penetration of water and dirt by using waterproof connector (IP67/68) as shown in [Figure 2](#).
5. Don't cut or strip the wire.

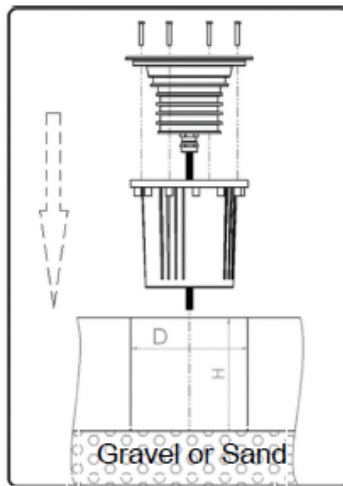

Figure 1

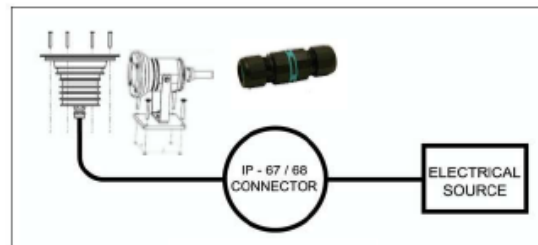
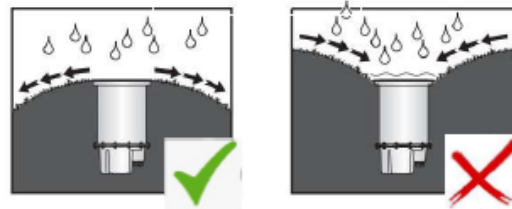

Figure 2



Product warranty does not cover failure to above instructions or not complying with product installation instructions and user instructions.